

grazia&co melbourne
1 / 10-14 advantage road
highett, vic, 3190
phone +61 3 9555 5760

grazia&co sydney
20 / 108 dunning avenue
rosebery, nsw, 2018
phone +61 2 8914 0350

dita stool



black perf



black



brass

australian made solid metal framed bars stool, finished with optional powder coat finishes. available in backless, open back or upholstered back versions. natural brass or stainless steel footrest detail with ply seat upholstered in commercial grade perforated or plain vinyl.

dita stacking chair also available – can stack up to 5 chairs high.

grazia&co®

plain and perforated vinyl

origin: china



zone vinyl - leather look

origin: usa

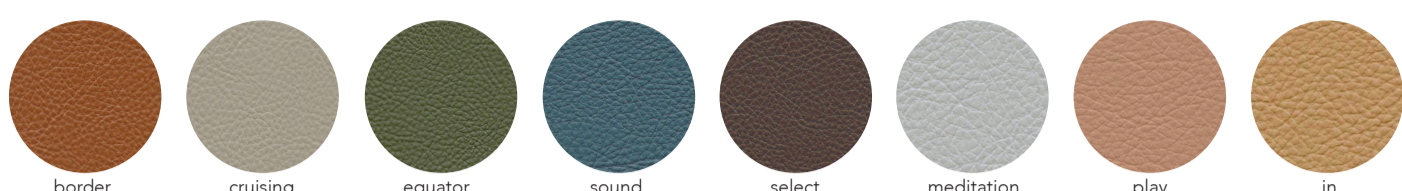

textured vinyl - linen look

origin: europe



koolio vinyl - finely textured , satin look

origin: canada

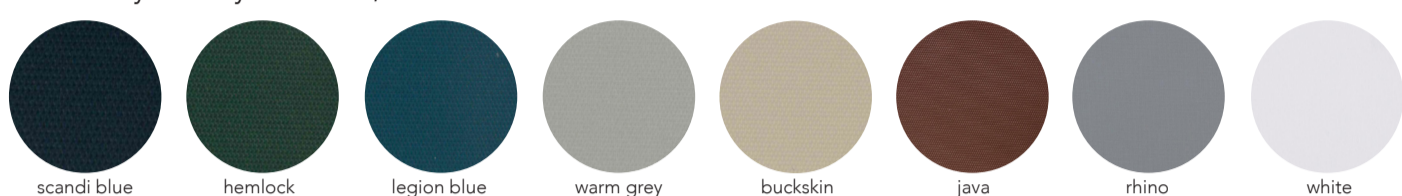

house leather - corrected grain

corrected grain leather
origin: europe

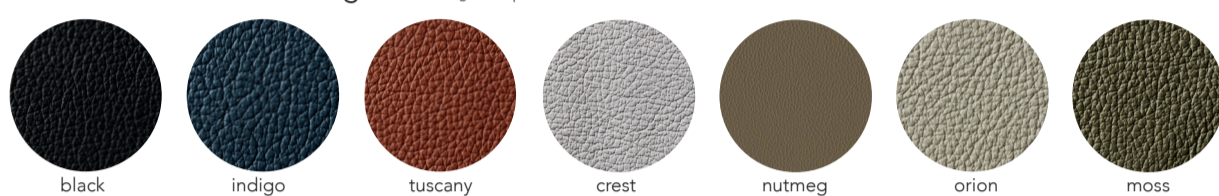

premium leather - semi aniline

semi aniline leather
origin: europe



boucle

composition: 28% acrylic / 24% cotton / 20% viscose / 16% wool / 12% polyester
origin: netherlands
martindale cycles: 80,000

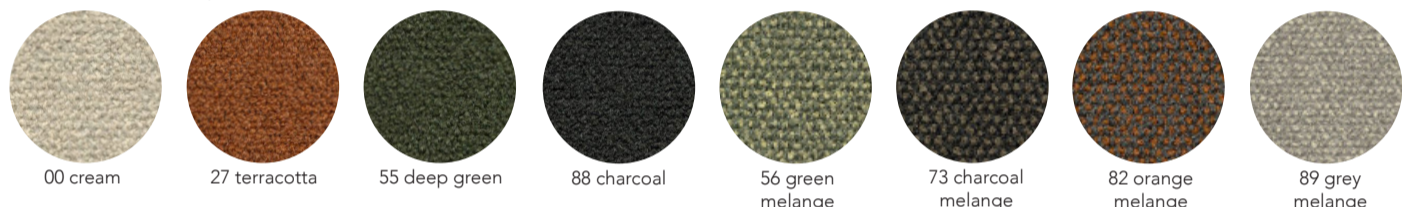

velvet

composition: 39% cotton / 28% alpaca / 11% polyester / 9% wool / 7% nylon / 6% viscose.
origin: italy
martindale cycles: 100,000

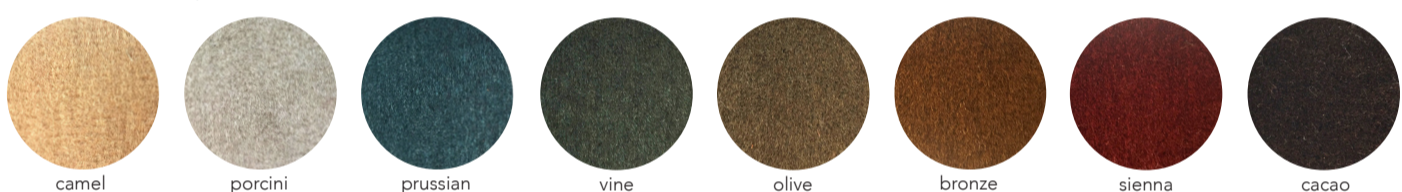

linen weave

composition: 15% linen / 40% cotton / 20% viscose / 20% acrylic / 5% polyester
origin: belgium
martindale cycles: 45,000

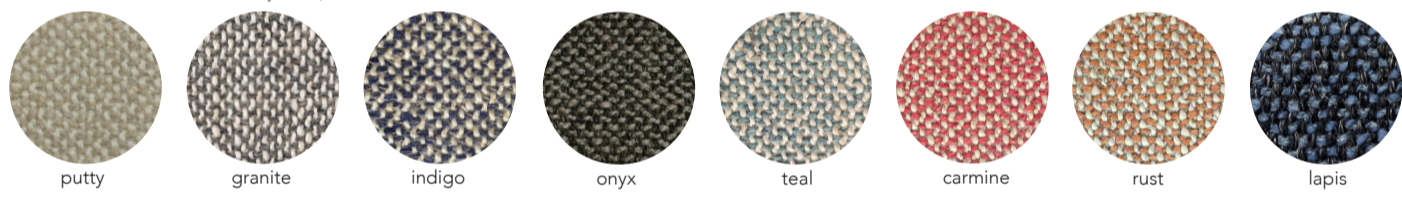

soft textured weave

composition: 100% polyester
origin: netherlands
martindale cycles: 45,000

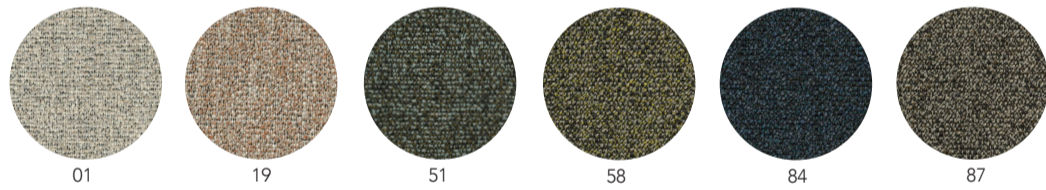

sheepskin

composition: 100% sheepskin wool
origin: australia



frame specifications

house powder coat

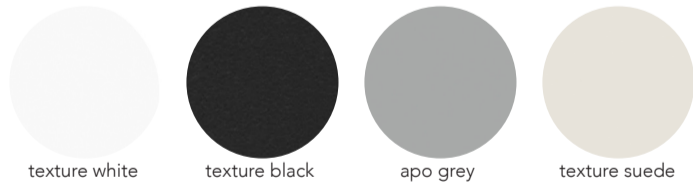

premium powder coat

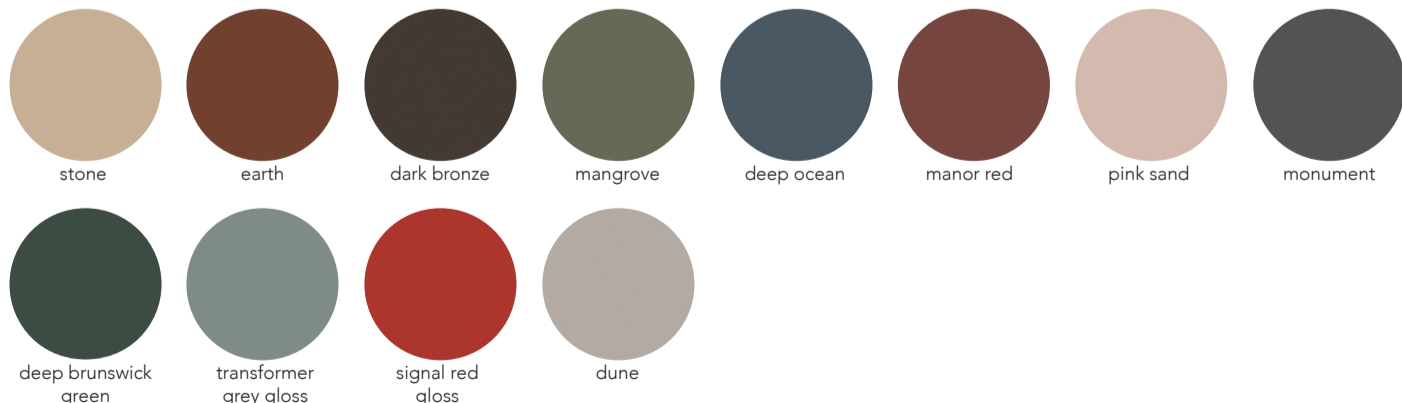

footrail

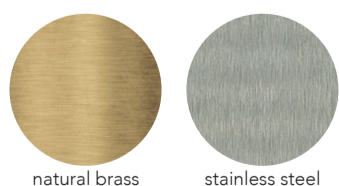

custom

custom finishes as specified

1 - junior

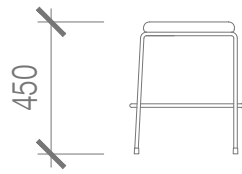
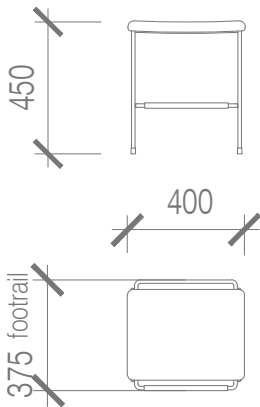

2 - no back

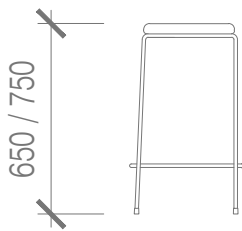
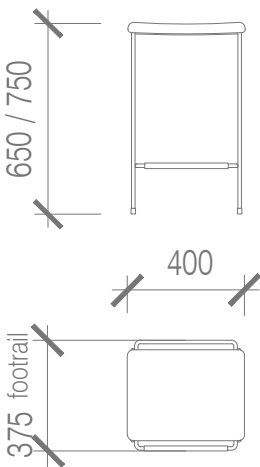

3 - open back

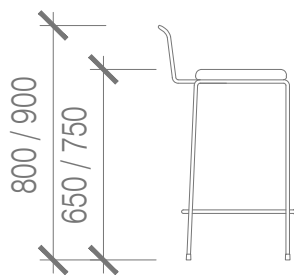
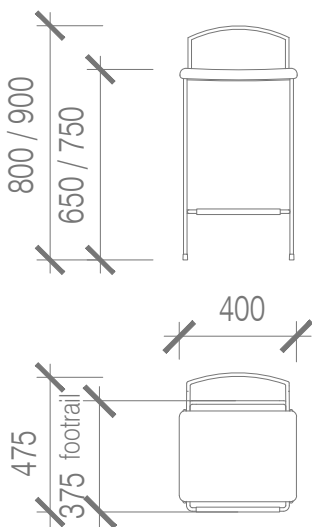

4 - upholstered back

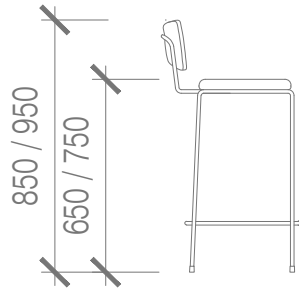
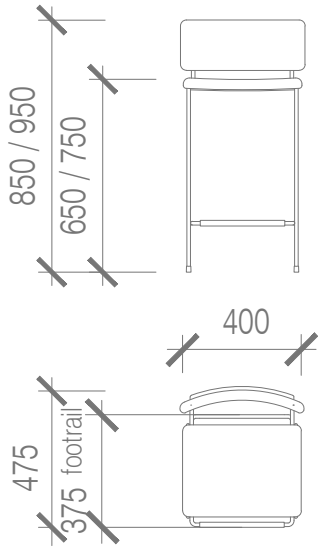

design registration
junior
no.201615714

no back
no.201616493

open back
no.201616492

upholstered back
no.201616491

year released
2016

warranty

- i. warranty period of 3 years for the structural integrity of the furniture under "normal use"
- ii. chipping and scratches on powder coated metal due to wear and tear are not warranted
- iii. metal pieces that are not specific to outdoor use that are exposed to the elements are not warranted
- iv. raw metals oxidise and tarnish over time and are not considered faults of manufacturing
- v. fabric and leather wear and tear are not warranted
- vi. fabric and leather that has faded or broken down due to exposure to sunlight or extreme weather conditions is not warranted
- vii. care instructions and warranty claims of fabric to be addressed with the textile supplier or specifier
- viii. it is the responsibility of the specifier and/or supplier that has selected and/or supplied a fabric or leather through 3rd party suppliers to ensure it is free of faults and fit for purpose and application
- ix. leather, sheepskin and other upholsteries with natural compositions can be prone to discolouration due to exposure to sunlight. this is not considered a fault and is not covered by warranty

all terms outlined in this document are applicable exclusively to projects and orders that are based in australia. for warranty claims outside australia, please note that a 12 month warranty period will apply, all claims are to be taken up with the international selling agent. to view the full warranty please refer to the [grazia&co website](#).

craftmanship: designed and manufactured in australia

materials: seat and backrest - ply with foam wrap, fully upholstered in specified fabric
frame - powder coated metal with brass or stainless steel footrail and plastic caps to feet

lead time: 10-12 weeks. lead times may vary during peak periods

suitability: indoor use



house leather care

protect from direct sunlight, heat and weather. dust with a clean dry cloth or use the soft brush attachment on your vacuum cleaner. remove all liquid and food spills immediately. wipe with a clean cloth dampened with proprietary brand leather cleaner suitable for a surface finish leather.

house vinyl care

maintaining and care of the upholstery should be done by regular vacuuming to remove dust and dirt. spot cleaning should be done immediately after a spill. acid based liquids such as coffee, wine and fruit juice need to be wiped off immediately. the longer a stain or spill remains on the fabric the more difficult it can be to remove. do not use abrasive alcohol based or solvent based cleaners. first spot clean with mild soap and water. using a sponge or very soft bristle brush to remove the stains, rinse with clean water.

velvet

all spills must be actioned right away- blotting the area immediately with a clean, dry absorbent cloth. never bleach, tumble dry, machine wash or iron. have velvet upholstery professionally cleaned according to the velvet suppliers' recommendations. to remove dust, vacuum regularly using low suction and soft brush attachment or using a soft lint brush.

cotton and polyester

protect from direct sunlight. vacuum regularly using low suction and soft brush attachment. professionally clean in accordance to the fabric suppliers' instructions. treat spills and stains as soon as possible with a clean damp cloth. dry in the shade, allow to dry thoroughly before use.

sheepskin

store away from direct sunlight and high heat sources, such as blow dryers and radiators. never rub or brush sheepskin when it's wet. to clean up small spills on your sheepskin upholstery, wipe with a damp cloth, and gently pluck any debris from the suede with tweezers. never use hot water. this causes permanent damage by stripping the natural oil, (lanolin) from the pelt making it very hard and rough. for professional cleaning, select a cleaner that specialises in leather/suede/fur.

custom specified upholstery

please refer to individual suppliers for information on care and maintenance of fabrics that have been specified by a designer, as these will be outside the standard grazia&co range. most interior upholstery fabric should be regularly vacuumed and kept away from direct sunlight.

powder coated items care

wash as required with warm soapy water using a soft clean cloth. for marine or commercial environments, we recommend regular cleaning. do not pressure wash or steam items that are powder coated. if powder coating chips due to a knock and / or rough treatment this is not covered by warranty. touch up paint can be purchased on request (depending on availability). scratches and chips should be repaired as soon as they appear.

to view the full care and maintenance please refer to the [grazia&co website](#).

