

grazia&co melbourne  
1 / 10-14 advantage road  
highett, vic, 3190  
phone +61 3 9555 5760

grazia&co sydney  
12b, 32 ralph street  
alexandria, nsw, 2015  
phone +61 2 8914 0350

## agent 86 sofa



made in australia, the agent 86 sofa is a fully upholstered low line sofa with a medium density commercial grade foam. featuring an upholstered inset plinth base with optional lumber cushions with feather fibre mix insert, plain seamed edge detail and concealed zip.

straight, curved, modular and custom versions available with matching ottomans. upholstery as specified.

grazia&co<sup>®</sup>

## leather

semi aniline leather  
origin: italy



## upholstered leather side table



## stone side table



## boucle

composition: 28% acrylic / 24% cotton / 20% viscose / 16% wool / 12% polyester  
origin: netherlands

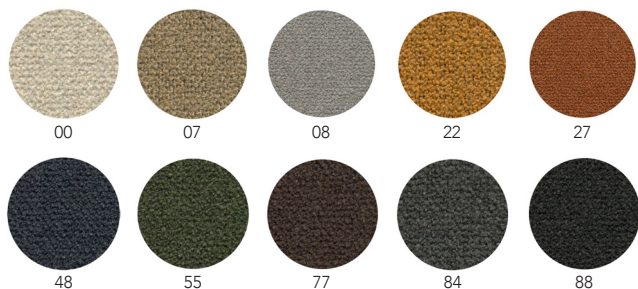

## velvet

composition: 39% cotton / 28% alpaca / 11% polyester / 9% wool / 7% nylon / 6% viscose.  
origin: italy



## linen weave

composition: 15% linen / 40% cotton / 20% viscose / 20% acrylic / 5% polyester  
origin: belgium



custom finishes as specified



# technical specifications

agent 86 sofa lineal

1

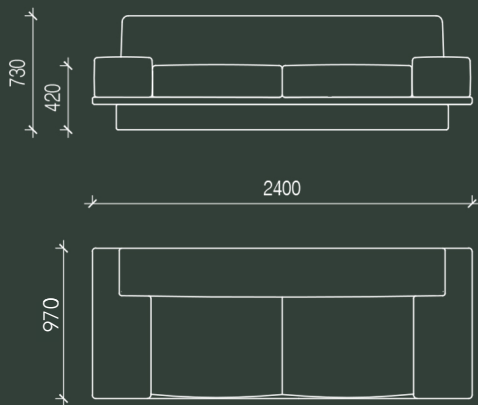

agent 86 sofa lineal 2400I

2

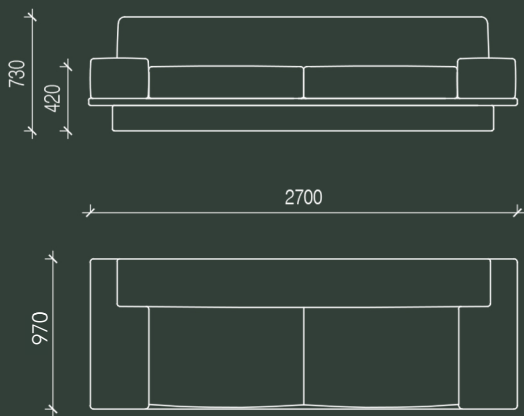

agent 86 sofa lineal 2700I

# technical specifications

agent 86 lineal + modular sofa

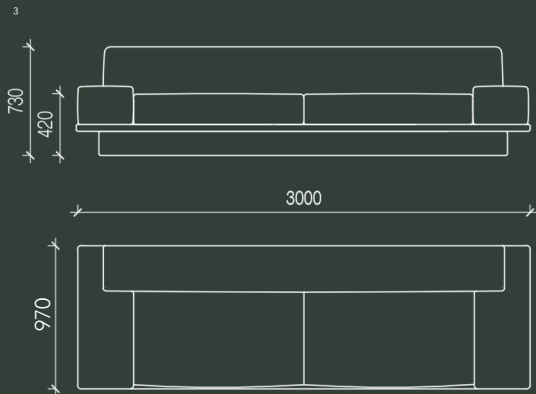

agent 86 sofa lineal 3000l

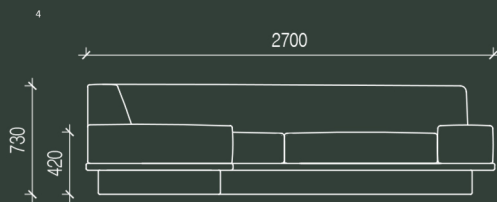
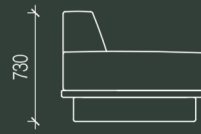

agent 86 modular sofa

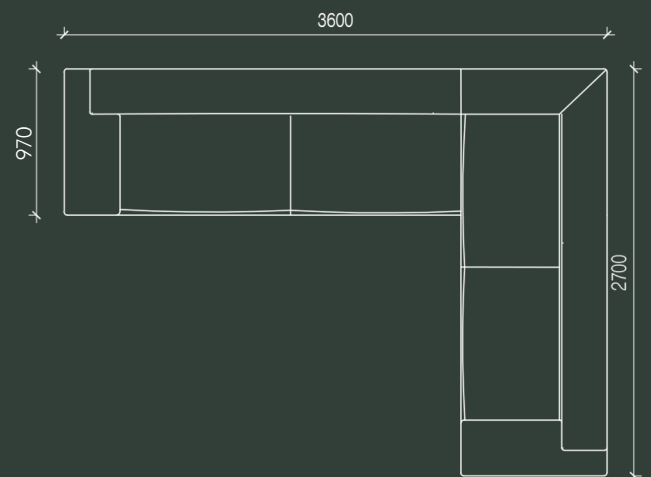

grazia&co<sup>®</sup>

# technical specifications

agent 86 lineal + modular sofa with side table

1

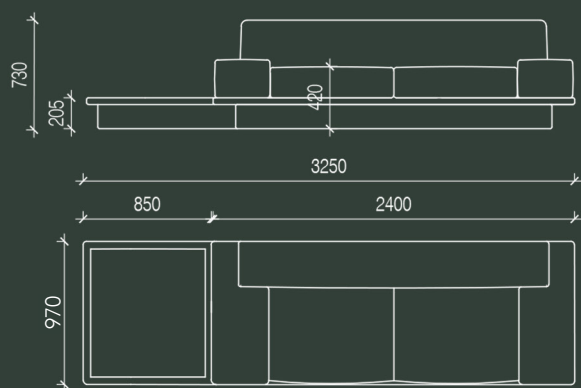

agent 86 sofa 2400l with side table



2

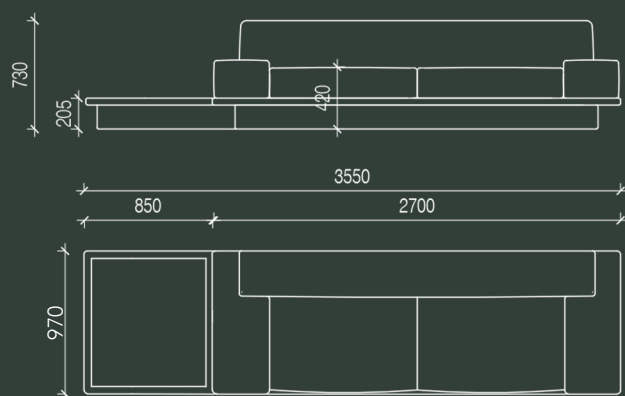

agent 86 sofa 2700l with side table



# technical specifications

agent 86 lineal + modular sofa with side table

3

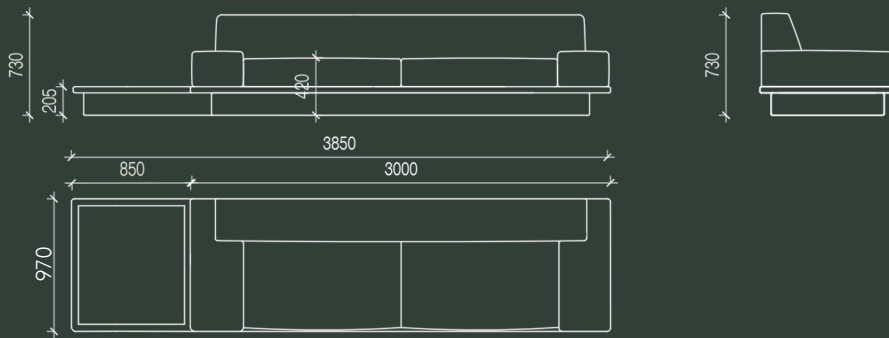

agent 86 sofa 3000l with side table

4

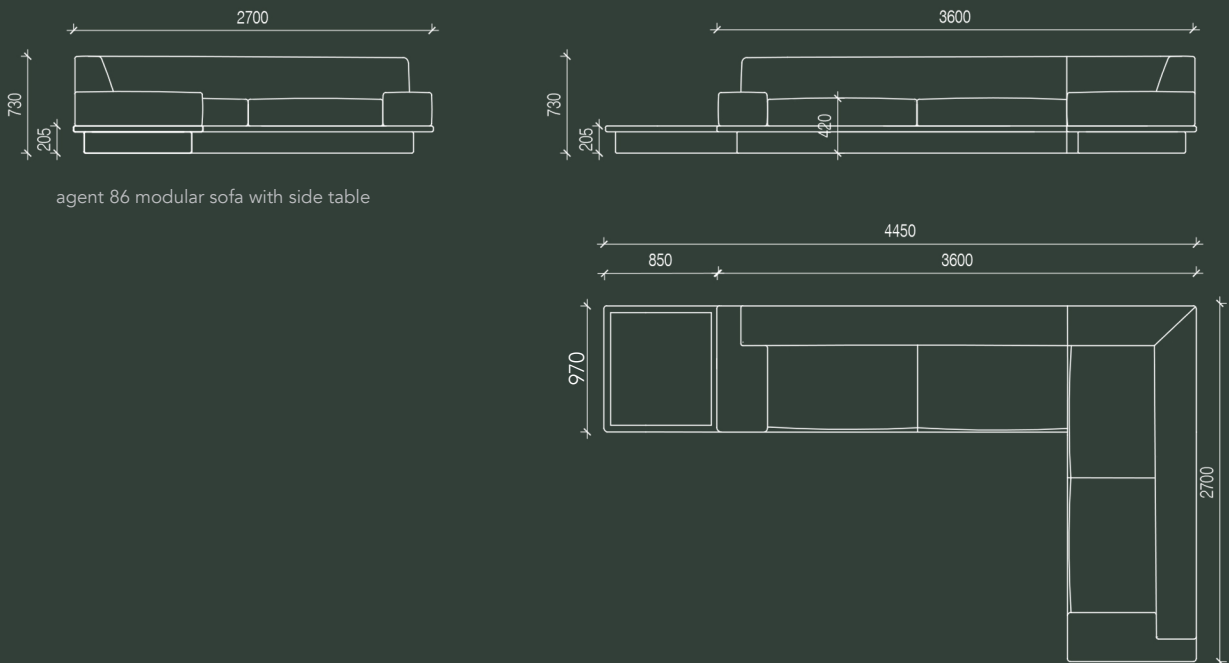

agent 86 modular sofa with side table

grazia&co<sup>®</sup>

# technical specifications

agent 86 curved sofa

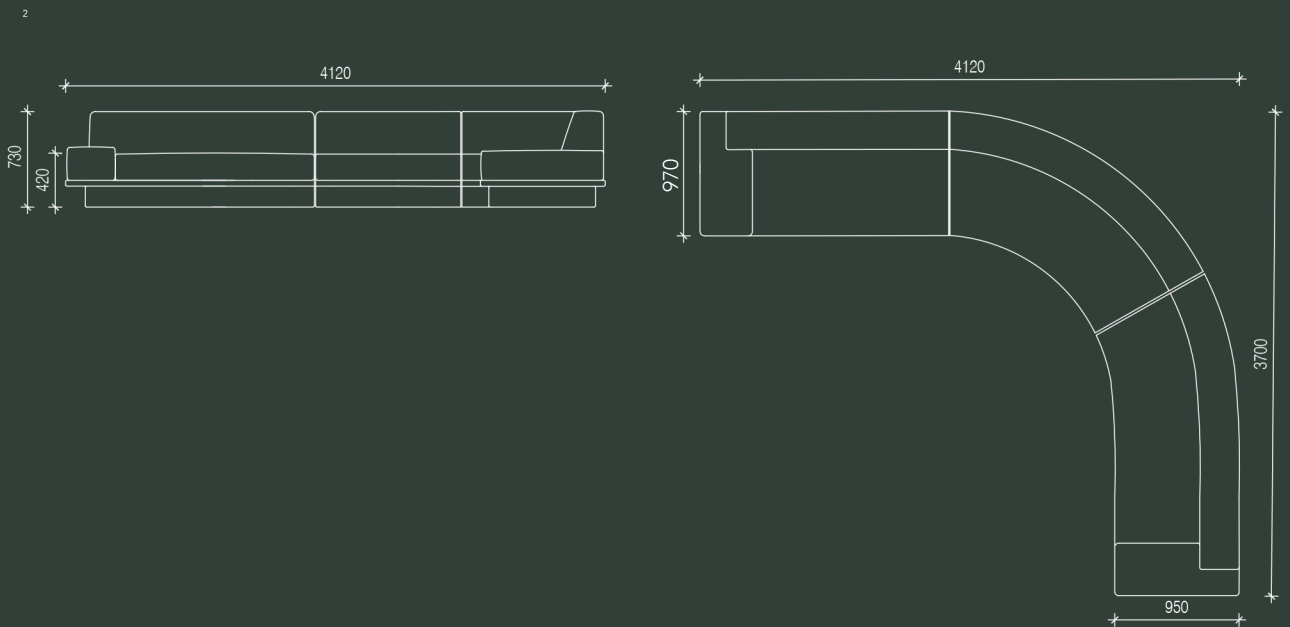
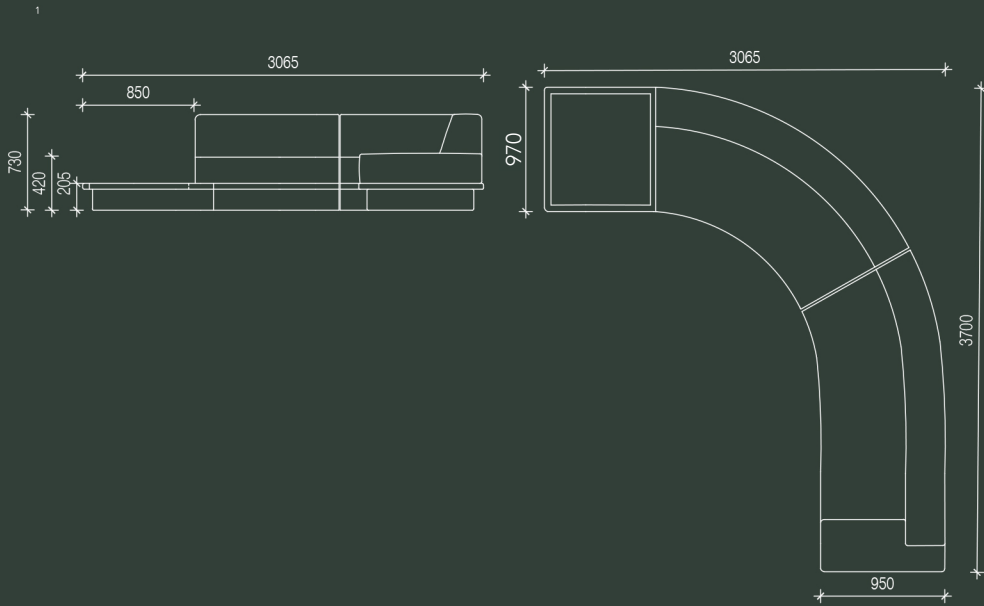

grazia&co<sup>®</sup>

## dimensions

---

agent 86 sofa

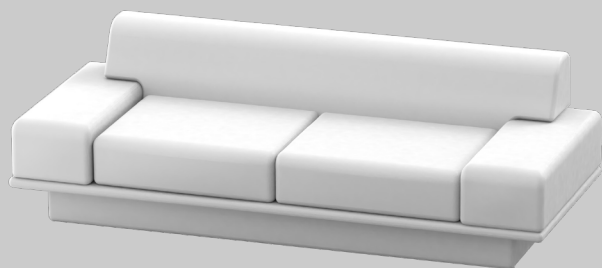

agent 86 sofa

2400l x 970w x 420sh / 730bh

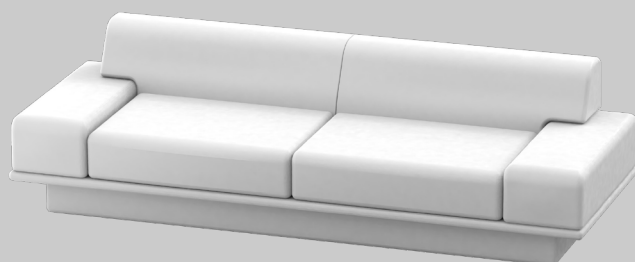

agent 86 sofa

2700l x 970w x 420sh / 730bh

*modular and custom sizes also available*

**grazia&co**<sup>®</sup>



## dimensions

---

agent 86 sofa

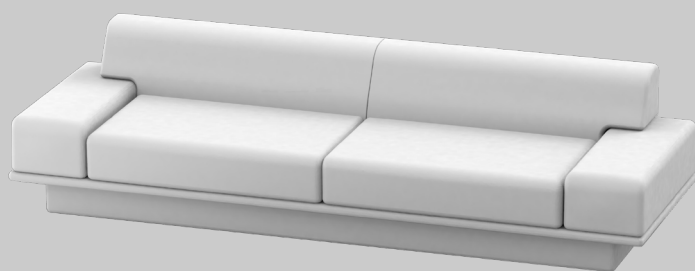

agent 86 sofa

3000l x 970w x 420sh / 730bh

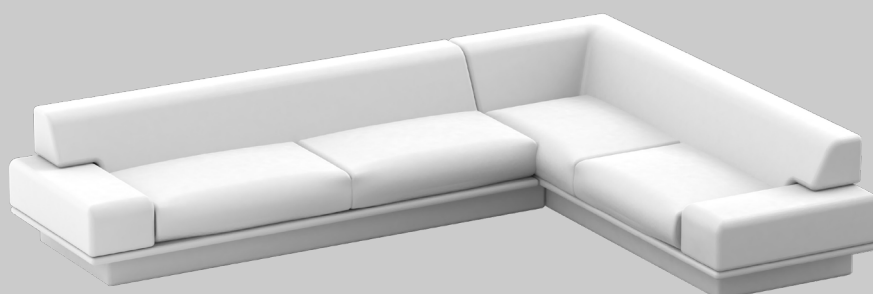

modular agent 86 sofa

3600l x 2700l at 970d x 420sh / 730bh

*modular and custom sizes also available*

**grazia&co**<sup>®</sup>

## dimensions

---

curved agent 86 sofa



curved agent 86 sofa

3700l x 4120l at 970d x 420sh / 730bh

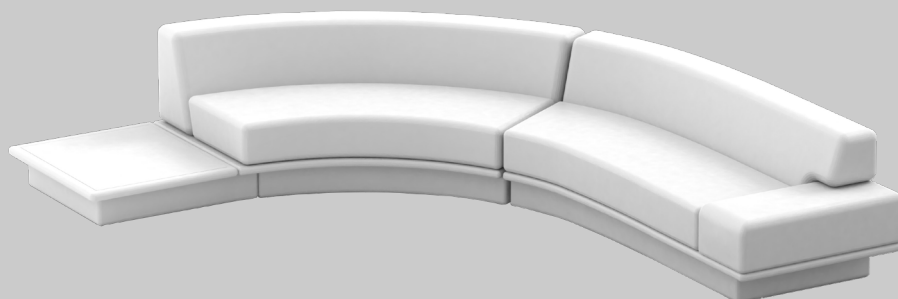

curved agent 86 sofa with side table

3700l x 3065l at 970d x 420sh / 730bh

*modular and custom sizes also available*

**grazia&co**<sup>®</sup>

**design registration no**  
201712614

**year released**  
2017 - standard  
2021 - curved

## warranty

- i. warranty period of 7 years for the structural integrity of the furniture under 'normal use'
- ii. the warranty covers the timber and metal frames, the suspension and the foam integrity.
- iii. fabric and leather wear and tear are not warranted.
- iv. fabric and leather that has faded or broken down due to exposure to sunlight or extreme weather conditions is not warranted.
- v. care instructions and warranty claims of fabric to be addressed with the textile supplier or specifier.
- vi. it is the responsibility of the specifier and/or supplier that has selected and/or supplied a fabric or leather through 3rd party suppliers to ensure it is free of faults and fit for purpose and application.

to view the full warranty please refer to the link below  
<https://graziaandco.com.au/grazia-terms-and-conditions/>

|                      |  |
|----------------------|--|
| <b>craftmanship:</b> | designed and manufactured in australia                     |
| <b>materials:</b>    | fully upholstered ply frame, foam and specified upholstery |
| <b>lead time:</b>    | 8-10 weeks. lead times may vary during peak periods        |
| <b>suitability:</b>  | indoor use   |



australian  
made



7 year  
warranty

**design registration no**  
201712614

**year released**  
2017 - standard  
2021- curved

### house leather care

protect from direct sunlight, heat and weather. dust with a clean dry cloth or use the soft brush attachment on your vacuum cleaner. remove all liquid and food spills immediately. wipe with a clean cloth dampened with proprietary brand leather cleaner suitable for a surface finish leather.

### velvet

all spills must be actioned right away- blotting the area immediately with a clean, dry absorbent cloth. never bleach, tumble dry, machine wash or iron. have velvet upholstery professionally cleaned according to the velvet suppliers' recommendations. to remove dust, vacuum regularly using low suction and soft brush attachment or using a soft lint brush.

### cotton & polyester

protect from direct sunlight. vacuum regularly using low suction and soft brush attachment. professionally clean in accordance to the fabric suppliers' instructions. treat spills and stains as soon as possible with a clean damp cloth. dry in the shade, allow to dry thoroughly before use.

### custom specified upholstery

please refer to individual suppliers for information on care and maintenance of fabrics that have been specified by a designer, as these will be outside the standard grazia&co range. most interior upholstery fabric should be regularly vacuumed and kept away from direct sunlight.

*please visit [grazia&co website](#) for further details.*



australian  
made



no direct  
sunlight



do not dry  
clean



do not  
machine  
wash



do not iron